



PYLONTECH

Lithium-Ion Phosphate Energy Storage System PowerCube-H1/H2 Operation Manual

Information Version: 2.1

This manual introduces PowerCube-H1/H2 from Pylontech. PowerCube-H1/H2 is a high voltage Lithium-Ion Phosphate Battery storage system. Please read this manual before you install the battery and follow the instruction carefully during the installation process. Any confusion, please contact Pylontech immediately for advice and clarification.

PowerCube-H1 and H2 are the same series of products. They are installed in the same way.

Contents

1.	SAFETY	3
1.1	Symbol	3
2.	SYSTEM INTRODUCE	5
2.1	Product Introduce.....	5
	The parameter of system	5
2.2	System Diagram	7
2.2.1	Multi battery string parallel connection by CAN communication between MBMS and BMS diagram (battery string qty. ≤ 6 set)	7
2.2.2	Diagram between BMS and battery modules:.....	7
3.	INSTALLATION	8
3.1	Tools	8
3.2	Safety Gear.....	8
3.3	System Working Environments Checking	9
3.3.1	Cleaning.....	9
3.3.2	Temperature	9
3.3.3	Cooling System	9
3.3.4	Heating System.....	9
3.3.5	Fire-extinguisher System.....	9
3.3.6	Grounding System.....	9
3.4	Package Items	10
	Accessories.....	10
	Unpacking and check the Packing List:	10
3.5	Handling and placement	11
3.5.1	Handling and placement of the battery module	12
3.5.2	Handling and placement of the rack.....	12
3.5.3	The fix and installation of the rack.....	12
3.5.4	Control Module (BMS) and all Battery Modules install into the Rack.....	12
3.5.5	Install the MBMS into a 19' standard rack [On the top of BMS, or use the rack configured by user]	13
3.6	Cables connection.....	13
3.6.1	Pay attention terms:.....	13
3.6.2	Cables Connection	13

CAN Communication Mode between MBMS and BMS (battery string qty. ≤ 6 set) (battery string qty. ≤ 6 set).....	13
CAN Communication Mode between MBMS and BMS Cable Diagram:	14
3.6.3 ADD Switch Setting (Address Assignment)	14
Under CAN Communication Mode between MBMS and BMS (battery string qty. ≤ 6 set).....	15
3.6.4 System turns on.....	15
3.6.5 System turns off.....	17
4. SYSTEM DEBUG	19
5. MAINTENANCE	20
5.1 Trouble Shooting:.....	20
5.2 Replacement of main component	22
5.2.1 Replacement of Battery Module	22
5.2.2 Replacement of Control Module (BMS).....	23
5.2.3 Replacement of 3 rd level Control Module (MBMS).....	23
5.3 Battery Maintenance	24
6. STORAGE RECOMMENDATIONS.....	26
7. SHIPMENT	26
ANNEX 1: CABLE CONNECTION DIAGRAM	27
ANNEX 2: INSTALLATION AND SYSTEM TURN ON PROGRESS LIST	28
ANNEX 3: SYSTEM TURN OFF PROGRESS LIST	30

1. Safety

The PowerCube-H1/H2 is a high voltage DC system, operated by skilled/qualified personnel only. Read all safety instructions carefully prior to any work and observe them at all times when working on with the system.

Incorrect operation or work may cause:



- injury or death to the operator or a third party;
- damage to the system hardware and other properties belonging to the operator or a third party.

Skills of Qualified Personnel

Qualified personnel must have the following skills:

- training in the installation and commissioning of the electrical system, as well as the dealing with hazards;
- knowledge of this manual and other related documents;
- knowledge of the local regulations and directives.

1.1 Symbol

	Danger	Lethal voltage! <ul style="list-style-type: none">● Battery strings will produce high voltage DC power and can cause a lethal voltage and an electric shock.● Only qualified person can perform the wiring of the battery strings.
	Warning	Risk of battery system damage or personal injury <ul style="list-style-type: none">● DO NOT pull out the connectors while the system is operating!● De-energize from all multiple power sources and verify that there is no voltage.
	Caution	Risk of battery system failure or life cycle reduction.



Read the product manual before operating the battery system!



Danger: Batteries deliver electric power, resulting in burns or a fire hazard when they are short circuited, or wrongly installed.

Danger: Lethal voltages are present in the battery terminals and cables. Severe injuries or death may occur if touch the cables and terminals.



Warning: DO NOT open or deform the battery module, otherwise the product will be out of

warranty scope

Warning: Whenever working on the battery, wear suitable personal protective equipment (PPE) such as rubber gloves, rubber boots and goggles.

Warning: PowerCube-H1/H2 system working temperature range: 0 °C ~ 50 °C ; Optimum temperature: 18°C~28°C. Out of the working temperature range may cause the battery system over / low temperature alarm or protection which further lead to the cycle life reduction as well as. It will affect the warranty terms as well.



Caution: Improper settings or maintenance can permanently damage the battery.

Caution: Incorrect inverter parameters will lead to a further faulty/damage to battery.

2. System Introduce

2.1 Product Introduce

PowerCube-H1/H2 is a high voltage battery storage system based on lithium iron phosphate battery, which is one of the new energy storage products developed and produced by Pylontech. It can be used to support reliable power for various types of equipments and systems. PowerCube-H1/H2 is especially suitable for those application scene which required high power output, limited installation space, restricted load-bearing and long cycle life.

The parameter of system

Product Type	POWERCUBE-H1 (720V50AH)
Cell Technology	Li-ion(LFP)
Battery System Capacity(kWh)	36
Battery System Voltage(Vdc)	720
Battery System Capacity(AH)	50
Battery Controller Name	SC1000-100
Battery Module Name	H48050
Battery Module Quantity(pcs)	15
Battery Module Capacity(kWh)	2.4
Battery Module Voltage(Vdc)	48
Battery Module Capacity(AH)	50
Battery Module Cell Quantity(pcs)	15
Battery System Charge Upper-Voltage(Vdc)	810
Battery System Charge Current(Standard)	10
Battery System Charge Current(Normal)	25
Battery System Charge Current(Max.)	50
Battery System Discharge low er-Voltage(Vdc)	675
Battery System Discharge Current(Standard)	10
Battery System Discharge Current(Normal)	25
Battery System Discharge Current(Max.)	50
Efficiency	96%
Depth of Discharge	80%(10~90%)
Dimension(W*D*H,mm)	600*505*2130
Communication	RS485\CAN
Protection Class	IP20
Weight (kg)	442.5
Operation Life(Years)	10
Operation Cycle Life	3500
Operation Temperature(°C)	0~50
Storage Temperature(°C)	-20~60
Product Certificate	TUV, CE
Transfer Certificate	UN38.3
Other:	
1) Battery Controller Dimensions(W*D*H)	442*390*132
2) Battery Module Dimensions (W*D*H)	442*390*100

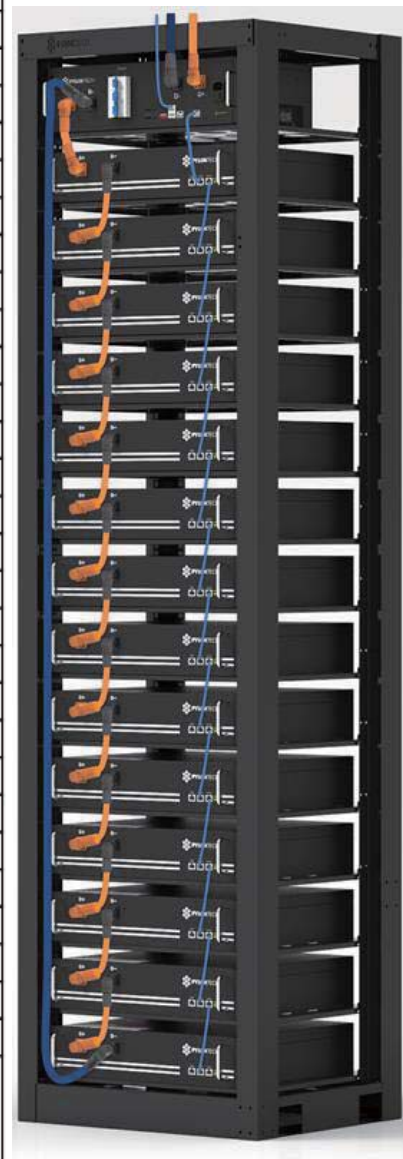

Product Type	POWERCUBE-H2 (576V74AH)
Cell Technology	Li-ion(LFP)
Battery System Capacity(kWh)	42.624
Battery System Voltage(Vdc)	576
Battery System Capacity(AH)	74
Battery Controller Name	SC1000-100
Battery Module Name	H48074
Battery Module Quantity(pcs)	12
Battery Module Capacity(kWh)	3.552
Battery Module Voltage(Vdc)	48
Battery Module Capacity(AH)	74
Battery Module Cell Quantity(pcs)	15
Battery System Charge Upper-Voltage(Vdc)	648
Battery System Charge Current(Standard)	14.8
Battery System Charge Current(Normal)	37
Battery System Charge Current(Max.)	74
Battery System Discharge lower-Voltage(Vdc)	540
Battery System Discharge Current(Standard)	14.8
Battery System Discharge Current(Normal)	37
Battery System Discharge Current(Max.)	74
Efficiency	96%
Depth of Discharge	80%(10~90%)
Dimension(W*D*H,mm)	600*505*2130
Communication	RS485\CAN
Protection Class	IP20
Weight (kg)	460.5
Operation Life(Years)	10
Operation Cycle Life	3500
Operation Temperature(°C)	0~50
Storage Temperature(°C)	-20~60
Product Certificate	TUV, CE
Transfer Certificate	UN38.3
Other:	
1) Battery Controller Dimensions(W*D*H)	442*390*132
2) Battery Module Dimensions (W*D*H)	442*390*132



2.2 System Diagram

2.2.1 Multiple battery string parallel connection via CAN communication between MBMS and BMS diagram (battery string qty. ≤ 6 sets)

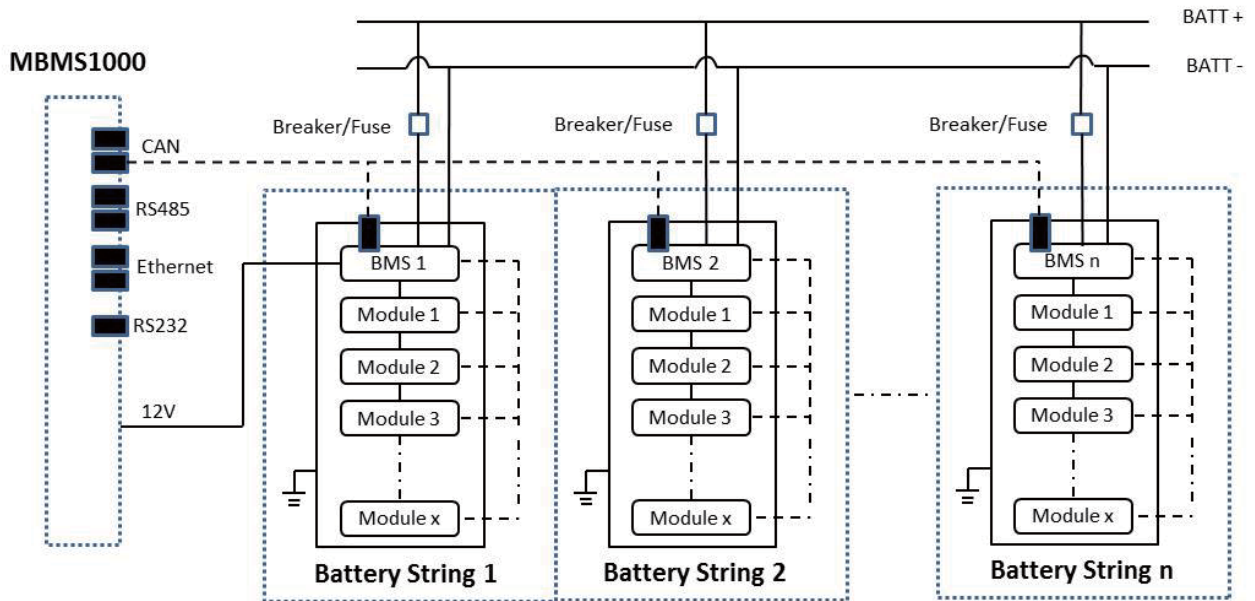

2.2.2 Diagram between BMS and battery modules:

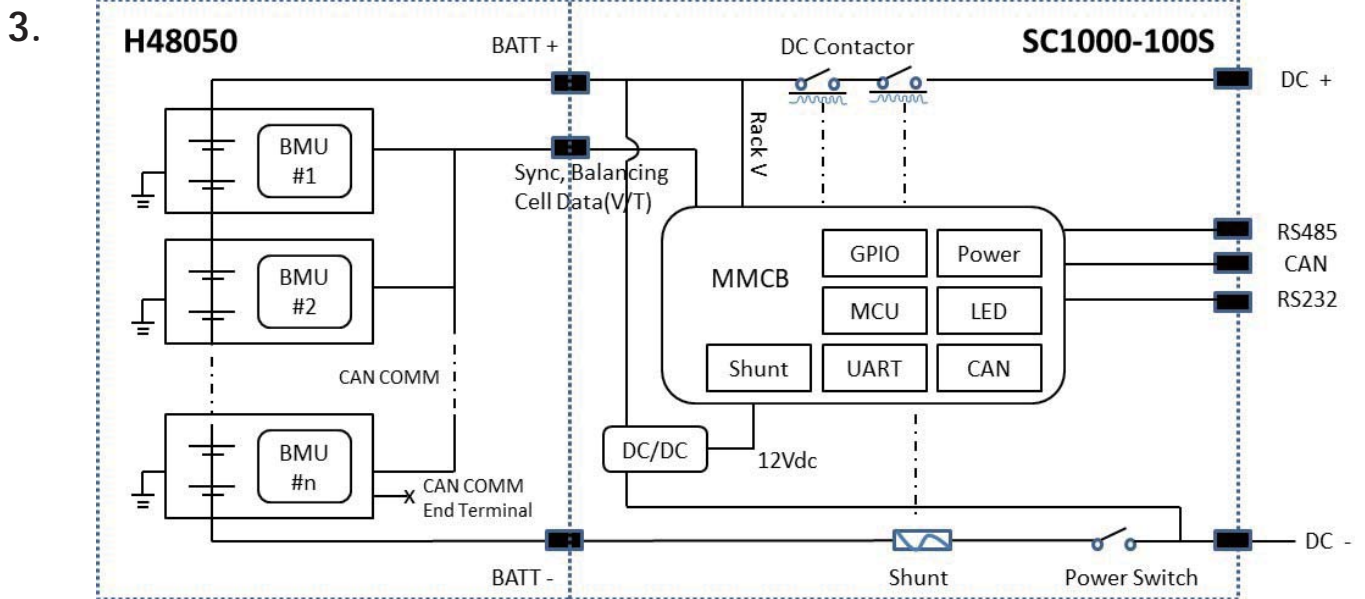

3. Installation

Please check every installation step in detail at <Annex 2: Installation and System Turn ON Progress List> during the install.

3.1 Tools

The following tools are required to install the battery pack:

 Wire Cutter	 Crimping Modular Plier	 Cable Ties
 Screw Driver Set	 Electric Screw Driver	 Sleeve Piece
 Adjustable Wrench		

NOTE

Use properly insulated tools to prevent accidental electric shock or short circuits. If insulated tools are not available, cover the entire exposed metal surfaces with available insulated alternatives, except their tips, with electrical tape.

3.2 Safety Gear

It is recommended to wear the following safety gear when dealing with the battery pack



3.3 System Working Environments Checking

3.3.1 Cleaning



The battery system has high voltage connectors. The cleaning condition will affect the isolation performance of the system.

Before installation and system power on, the dust and iron scurf must be removed to keep a clean environment. And the environment must have certain anti-dust ability.

Dust and humidity condition shall be regularly checked during the system continuous operation. If it's detected the above two elements are not in the working range, the system shall be stopped for cleaning purpose.



Danger: the power cables and plugs will have high voltage DC power from serial connected battery modules (battery module has active DC power at terminal all the time), must be careful to handle the Power Plugs.

3.3.2 Temperature



PowerCube-H1/H2 system working temperature range: 0°C~50°C; Optimum temperature: 18°C~28°C.

Caution: Out of the working temperature range will cause the battery system over / low temperature alarm or protection which further lead to the cycle life reduction.

3.3.3 Cooling System



It is essential to equip a cooling system to keep the battery system in a relevant temperature range.

Caution: Out of the working temperature range will cause the battery system over / low temperature alarm or protection which further lead to the cycle life reduction.

3.3.4 Heating System



It is essential to equip a heating system to keep the battery system in a relevant temperature range. If the environment is lower than 0°C, the system may be shut down for protection purpose. It is necessary to open the heating system at first.

Caution: Out of the working temperature range will cause the battery system over / low temperature alarm or protection which further lead to the cycle life reduction.

3.3.5 Fire-extinguisher System



The room must be equipped with fire-extinguisher system for safety purpose.

The fire system needs to be regularly checked to be in normal condition. Refer to the using and maintenance requirements please follow local fire equipment guidance.

3.3.6 Grounding System



Before the battery installation must make sure the grounding point of the basement is stable and reliable. If the battery system is installed in an independent equipment cabin (e.g. container), must make sure the grounding of the cabin is stable and reliable.

The resistance of the grounding system must $\leq 100m \Omega$

3.4 Package Items

Accessories

The type and quantity of the accessories are subject to the battery packing list.

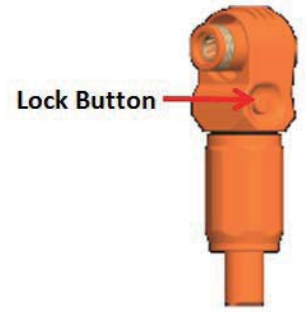

NOTE

Power cable uses water-proofed connectors. It must keep pressing this Lock Button during pulling out the power plug.

Unpacking and check the Packing List:

Power Cable + (Battery Module and Main Controller Serial Connection)	Orange/0.16m/4AWG/2 Orange Surlok Terminal	pcs	1
--	--	-----	---

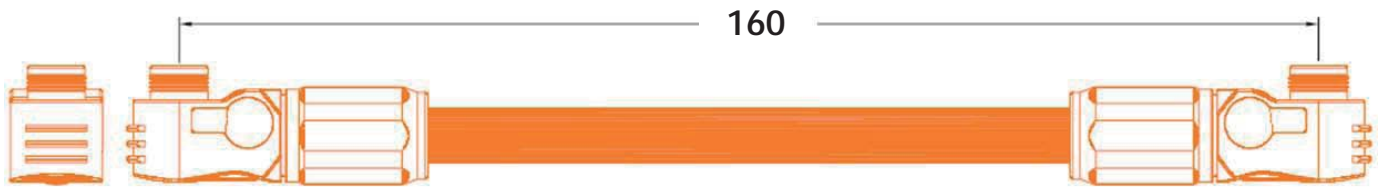

Power Cable - (PH Main Control Module Battery)	Black/2m/4AWG/2 Black Surlok Terminal	pcs	1
--	---------------------------------------	-----	---

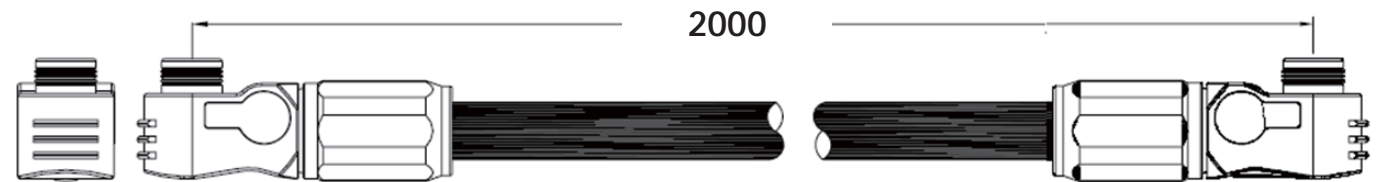

Power Cable (Battery Module Upper and Lower Serial Connection)	Orange/0.18m/4AWG/1 Orange & 1 Black Surlok Terminal	pcs	14
--	--	-----	----

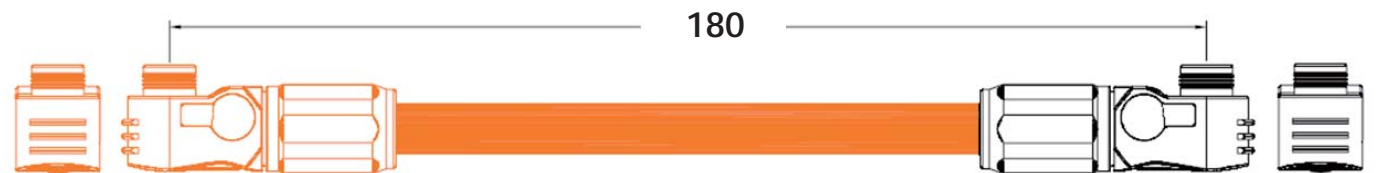

Battery Cascade Communication Cable (0.18m)	Black/0.18m/8 Core Super 5th Class Twisted-pair Wire/RJ45	pcs	15
---	---	-----	----

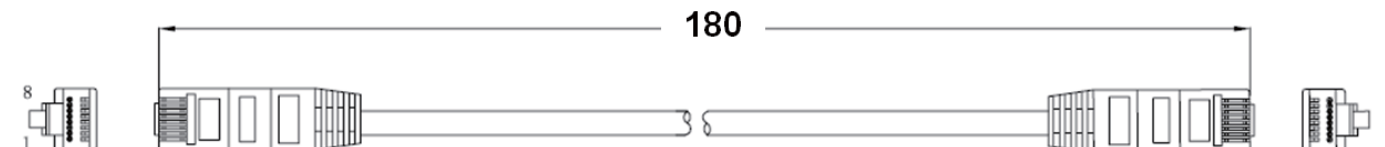

External Battery CAN Communication Cable (direct)	Black/3.5m/Super 5th Class Twisted-pair Wire/2 RJ45 terminal	pcs	1
--	---	-----	---

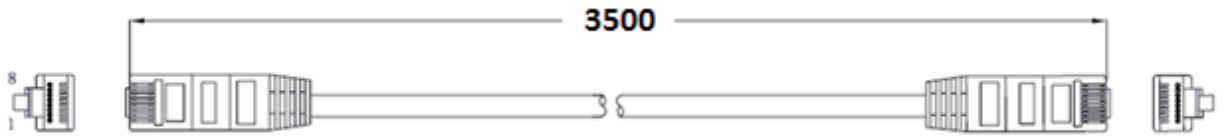

External Power Cable +	Orange/2m/4AWG/SURLOK Terminal/25-8 Terminal	pcs	1
------------------------	---	-----	---

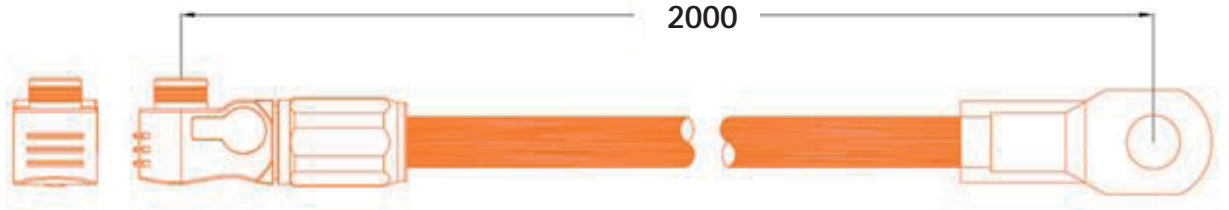

External Power Cable -	Black/2m/4AWG/SURLOK Terminal/25-8 Terminal	pcs	1
------------------------	--	-----	---

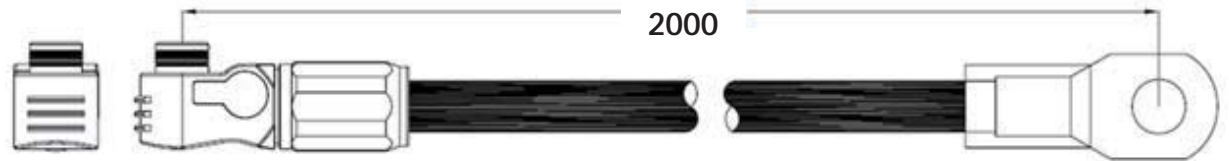

For external power supply control module there is an additional AC power cable:

AC Power Cable (Australia Standard)	Black/2.5m/3*0.75mm2/Australia Standard	pcs	1
--	--	-----	---

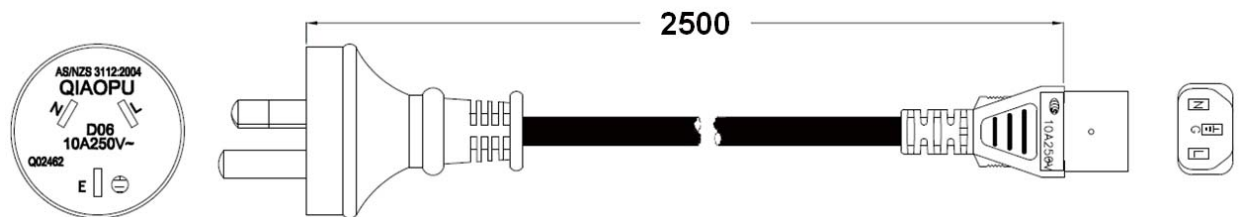

3.5 Handling and placement



Warning: The battery rack is IP00. It must be installed in a restricted access area;

Warning: PowerCube-H1/H2 is a high voltage DC system, operated by qualified and authorized personnel only.



3.5.1 Handling and placement of the battery module

Sigel battery module is 24kg. If without handling tools must have more than 1 manto handling with it.

3.5.2 Handling and placement of the rack

If without handling tools must have more than 4 men to handling with it.

3.5.3 The fix and installation of the rack

The rack must be fixed installed on the basement or carriage on the wall with M10 screws.

Battery rack basement holes bitmap (unit: mm):

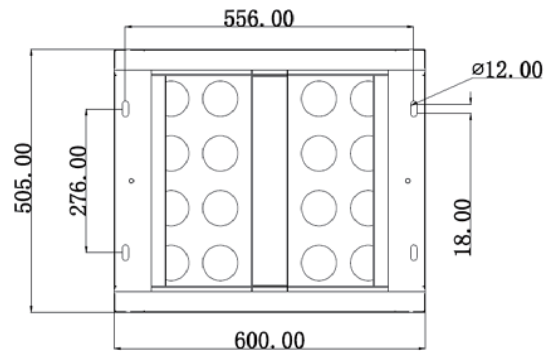

Battery rack wall
mm):

fixed holes bitmap (unit:

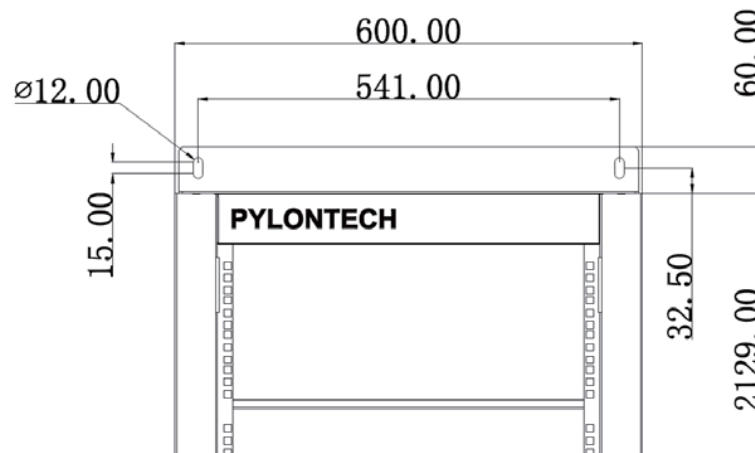

3.5.4 Control Module (BMS) and all Battery Modules install into the Rack

- Install the **buckle nuts**. The position of nuts must meet the position of the control module (BMS) and all battery modules.
- Install the control module (BMS) and all battery modules in. Each module uses 4 **screws** to fix. Refer to **chapter 3.5.1**

3.5.5 Install the MBMS into a 19' standard rack [On the top of BMS, or use the rack configured by user]

- Install the **buckle nuts**. The position of nuts must meet the position of the MBMS.
- Install the MBMS in. Uses 4 **screws** to fix.

3.6 Cables connection

3.6.1 Attention:



Danger: The battery system is high voltage DC system. Must make sure the grounding of the rack is stable and reliable.

Danger: All the plugs and sockets of the power cables must be **from orange to orange and black to black**. Otherwise it will cause personal injury.



Danger: No short circuit or reserved connection of the battery system's positive and negative port.

Caution: Wrong communication cables connection will cause the battery system failure.



Grounding

The PowerCube-H1/H2 modules' grounding is based on metal directly touch between the module's surface and rack's surface. So it don't need grounding cables at all. If uses normal rack, it should remove the paint at the corresponding grounding point.



3.6.2 Cables Connection

Note: Power cable uses water-proofed connectors. It must keep pressing this Lock Button during pulling out the power plug.

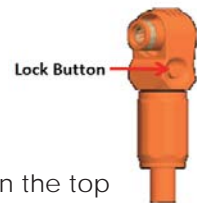

If there are more than 1 rack of PowerCube-H1/H2, there will require a MBMS on the top which aggregate information from all the BMS and communicate with inverter/PCS.

CAN Communication Mode between MBMS and BMS (battery string qty. ≤ 6 sets)

When system configured PowerCube-H1/H2 ≤ 6 sets. The communication between PowerCube-H1/H2s uses CAN cascade communication mode. The communication between the MBMS and the BMS of 1st PowerCube-H1/H2 uses CAN communication mode.

CAN Communication Mode between MBMS and BMS Cable Diagram:



Note: The 1st PowerCube-H1/H2 should be installed nearest to the MBMS.

3.6.3 ADD Switch Setting (Address Assignment)



ADD Switch is a 6 bit dial switches to manually distribute the communication address of the battery system. Nether position is OFF, means "0". Upper position is ON, means "1". For BMS, 1st bit to 5th bit is for address allocation, and the 6th bit dial switch support a 120Ω resistance (**Terminal Resistance**).

Under CAN Communication Mode between MBMS and BMS (battery string qty. ≤6 set)

The MBMS's ADD Switch shall set as "1000X₁X₀" with 1st bit at '1' always. The last 2 bits are terminal resistances.;

X₁ address should correspond with CAN1 port connection, X₀ address should correspond with CAN0 port connection.

When the external communication is via CANBUS, and if this equipment requires terminal resistance, then X₀/X₁ should be set to "1". If this equipment not require terminal resistance, then X₀/X₁ should be set to "0"; If there are multiple external devices communicate with MBMS via CANBUS, then the X₀/X₁ shall follow varying external device requirement.

The BMS's first five bits must set in below <**BMS's Address Configure Table**>. The last (farthest position) BMS's terminal resistance must set in "1" (X=1), and other BMS's terminal resistance must set in "0".

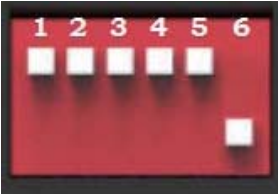

The address is configured follow ASCII code: ("X" is terminal resistance).

BMS's Address Configure Table:

Battery String	Address Bit	Battery String	Address Bit	Battery String	Address Bit	Battery String	Address Bit
1	10000X	9	10010X	17	10001X	25	10011X
2	01000X	10	01010X	18	01001X	26	01011X
3	11000X	11	11010X	19	11001X	27	11011X
4	00100X	12	00110X	20	00101X	28	00111X
5	10100X	13	10110X	21	10101X	29	10111X
6	01100X	14	01110X	22	01101X	30	01111X
7	11100X	15	11110X	23	11101X	31	11111X
8	00010X	16	00001X	24	00011X	32	00000X

Note: The above setting is following normal standard. But some PCS or Inverter's address is changeless, can't be set. In this case the address setting must follow such equipment's guidance. If the address setting is failed, please contact the distributor or Pylontech.

3.6.4 System turns on



Double check all the power cables and communication cables. Make sure the voltage of the PCS is same level with the battery system. Check all the power switch of every battery system is

OFF.



Warning: MBMS must be turned on after all battery strings self-check finish.

- (1) Check the UPS is turned on and supplying power if configured.
- (2) Switch the external power or PCS on, to make sure all the power equipments can work normally.
- (3) Turn on the 1st BMS (Battery Control Modules) of battery string:
The second BMS must be operated after the first battery string's self-check is successful.
From 1st BMS to the last BMS Then turn on the battery strings on one by one.
 - Turn on the "POWERRELAY SWITCH":



Warning: This Power Relay Switch must be sure turned ON. Otherwise it will affect automatic checking process and causes danger.

- Turn on the "POWER SWITCH":



Caution: When the breaker is tripped off because of over current or short circuit, must wait after 30min to turn on it again, otherwise may cause the breaker damage.

- The battery string's system will check itself, if work normal the battery string system will go to self-check mode.
If the BMS and all battery modules are working normally, every status LED will lighting green, that's mean self-check are pass. Self-check will be finish within 10sec.



If the BMS can't receive communication from upper equipment because of the communication is off, the "STATUS" lamp will light red after 30sec. That doesn't means failure existed, it means this battery string is ok while the external communication is off.

Warning: If has failure during the self-check, must debug the failure then can start next step.

If the "STATUS" lamp shows red from beginning, it means there has some failure in the battery string, the Power Relays in BMS will open, must debug at first.

- (4) Switch the MBMS on after all the BMS turn on successful:



And check whether MBMS is working. The "STATUS" lamp will light green.

When the voltage difference between strings is smaller than the parameter, the battery string will do the parallel operation. Then the power relays in BMS will switch ON after 30 seconds. The "STATUS" lamp of the BMS will light green;

When the voltage difference between strings is bigger than the parameter, the battery string will NOT do the parallel operation, the "STATUS" lamp of the BMS will light red, but it is normal; such battery string will be paralleled in during charging stage automatically.

Note: If the MBMS can't build communication with other equipment, the system can't work normally. External device should communicate with battery system through LAN, CAN or RS485. Otherwise maybe cause battery system work abnormal.



Caution: During first time power on, the system will require to do fully charge progress for SOC calibration purpose.

Caution: The whole Battery Energy Storage System (BESS) after installation or restart the system when long time not in using should charge it to full at first. There will be a regularly (3 month) fully charge requesting during continuous operation as well, it will be handled automatically by the communication between BESS and external device.

3.6.5 System turns off

When failure or before service, must turn the battery storage system off:

- (1) Soft-off the PCS through PCS's control panel.
- (2) Turn off the switch between PCS and battery string (PowerCube-H1/H2), or turn off the power switch of PCS, to make sure no current transmission through battery string and PCS.
- (3) Turn off the "Power Switch" of the BMS.





Danger: DO NOT turn off the “**Power Relay Switch**” during normal running condition, only in emergency case it could be turned off directly. Otherwise will cause this battery string current surge by another battery strings.



(4) Turn off the “Power Switch” of the MBMS. If the ESS configures only single battery without MBMS, then ignore this operation step.



(5) Turn off the UPS if configured.

The UPS can turn on if have equipment must keep running can't turn off. Otherwise must turn off the UPS to save its power.



Caution: Before change the battery module for service, must charge/discharge the replaced battery same voltage to the other in system battery modules. Otherwise the system need long time to do the balance for this replaced battery module.

NOTE

After installation, DO NOT forget to register online for full warranty:

www.pylontech.com.cn/service/support

4. System Debug

This system debug is for BESS system (Battery Energy Storage System). BESS system can't do the debug itself. It must operation with configured UPS, PCS and EMS system together.

Debug Step	Content
Prepare of debug.	Turn on the BESS system, refer to chapter 3. Before turn on the whole BESS system turn on the load is not allowed! Remark: Except the BESS, if other equipments have its own system turn on step, must follow its own system operation manual.
System function test.	Each component system debug: Power supply Check if the External Power Supply (e.g. UPS) is working normally. Communication Test: Check the communication between the BESS system and communicated devices normal or not, has alarm or not. Power Conversion System Test: Before conjoint test must test the Inverter System turn on progress at first. And check the parameters meet BESS requirement or not. BESS Test: Charge/Discharge test; Test stop charging, stop discharging, current limiting functions, etc. Caution: Before turn on the BESS system must setup all the parameters of the PCS and EMS at first.
Monitor function test. (If configured.)	Check whether the data of the BESS system is showing on the monitor system normally.
EMS conjoint test (If configured.)	If the EMS system has running monitor requirements, check if the BESS system is following EMS instructions.
Trial operation test.	After the system debugged, run the system a period as test (testing with low load), to test the high voltage DC system is fit for the contract.

5. Maintenance

5.1 Trouble Shooting:



Danger: The PowerCube-H1/H2 is a high voltage DC system, operated by qualified and authorized person only.

Danger: Before check the failure, must check all the cables connection and setting of ADD Switches are right or not (refer to chapter 3), and the BESS system can turn on normally or not.

No	Problem	Possible Reason	Solution
1	Turn on the BMS. All battery modules' status LED is not working.	<ul style="list-style-type: none"> ● The DC/DC power board or control board is failure. ● The communication cable from BMS to the first battery module is broken ● Power cable is broken; 	<ul style="list-style-type: none"> ● Change the control module (BMS module).. ● Change the broken communication cable; ● Check all the power cables and connections are fine or not;
2	Turn on the BMS. The Status LED for BMS is not working. But all battery modules' status LED is lighting green.	<ul style="list-style-type: none"> ● The control board is failure. 	<ul style="list-style-type: none"> ● Change the control module (BMS module).
3	Turn on the BMS. The Status LED is lighting red. But all battery modules' status LED is lighting green.	<ul style="list-style-type: none"> ● This battery string is under protection. It is possible Over Current Protection or Failure Protection. ● Communication cables failure; ● Battery String is reversed connection. 	<ul style="list-style-type: none"> ● Through the monitor or maintenance software check the battery cell, battery module has alarm or not. ● Check the Communication Cables; ● Reversed connection is serious danger!
4	The BMS's Status LED is lighting red and some the battery module's status LED is lighting green but some is lighting red.	<ul style="list-style-type: none"> ● This battery string is under protection. It is possible Over Current, Over Voltage, Low Voltage, Over Temperature, Low 	<ul style="list-style-type: none"> ● Use the monitor or maintenance software to check the battery cell, battery module has protection and failure or not.

		Temperature or Failure Protection.	
5	Cannot close the power Switch.	<ul style="list-style-type: none"> ● DC Output breaker is fault. 	Check the DC output breaker is fault or not. If it is fault, change the control module (BMS module).
5	Open the Power Relay Switch, but the relay can't be open.	<ul style="list-style-type: none"> ● The main control board is failure. ● The wire of the output relay, or the wire of the power relay switch in the BMS is broken 	<ul style="list-style-type: none"> ● Change the control module (BMS module). ● Check the wire got loose or broken? Fix it. Or the control module (BMS module).
5	Turn on the BMS. The Status LED is flashing red.	Self-check can't pass.	If something is wrong, please contact with seller or sells agent.
6	Turn on the BMS. The Status LED is lighting red. And the buzzer is noising.	<ul style="list-style-type: none"> ● Output relay is non-separable switching,. ● The buzzer is failure ; ● Output relay False alarm; 	<ul style="list-style-type: none"> ● Check the output relay. If fault find out the short circuit reason. Change the relay or the control module (BMS module). ● Change the control module (BMS module).
7	Turn on the BMS. The Status LED shows normal. But the output relay can't be actuation.	<ul style="list-style-type: none"> ● The wire of the output relay or the wire of the power relay switch in the BMS is broken. ● Power Relay Switch is open; 	<ul style="list-style-type: none"> ● Check the wire got loose or broken? Fix it. Or change the control module (BMS module). ● Close the Power Relay Switch.
8	Turn on the BMS. The one and the following of the battery module's Status LED lighting red or not lighting.	<ul style="list-style-type: none"> ● This battery module has failure; ● Its communication cable failure; ● Its Address Distribution failure. 	<ul style="list-style-type: none"> ● Change this battery module; ● Check the communication cable; ● Check by professional stuff.
9	Single Cell is over voltage/ low voltage. (Check through the monitor or maintenance software.)	<ul style="list-style-type: none"> ● Cell voltage sampling failure. ● Cell failure; 	<ul style="list-style-type: none"> ● Check the wires of cell sampling module; ● Change this battery module.
10	Battery module shows the temperature is -40°C. (Check through the monitor or maintenance software.)	The wires of temperature sampling failure.	Check the wires of temperature sampling module. Or change this battery module.
11	Another failure	Cell failure or electrical	Can't find out failure point

		board failure.	or can't check. Please contact with distributor or Pylontech.
--	--	----------------	---

5.2 Replacement of main component



Danger: The PowerCube-H1/H2 is a high voltage DC system, operated by qualified and authorized person only.

Danger: Before replace the main component must shut off the maintenance battery string's power. Must confirm the **D+** and **D-** terminal are without power. The turn off progress refer to chapter 3.6.5.

5.2.1 Replacement of Battery Module

5.2.1.1 Use a charger to charge the new battery module and existing module to full (SOC 100%)

5.2.1.2 Turn off the whole battery string's power. Must confirm the **D+** and **D-** terminal are without power. The turn off progress refer to chapter 3.6.5.

5.2.1.3 Pull out the Plug of Power Cable +/- . Pull out the plug of communication cable.

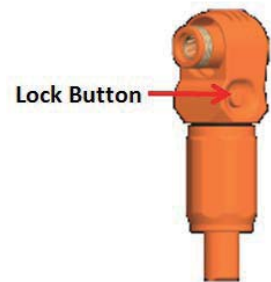

Danger: the power cables and plugs still have high voltage DC power from serial connected battery modules (battery module can't be turned off), must be careful to handle the Power plugs with insulated tools.

5.2.1.4 Dismantle the 4 screws of the battery module's front face.



5.2.1.5 Handle the battery module out of the rack, and put it to the appoint place.



Warning: Single battery module is 24kg. If without handling tools must more than 1 personnel to handling with it. If install in high place of the rack it must more than 2 personnel.

5.2.1.6 Install the new battery module (see before 5.2.1.1). And connect the cables. Refer to

chapter 3.5.

5.2.1.7 Turn on this battery string. Refer to chapter 3.6.

5.2.2 Replacement of Control Module (BMS)

5.2.1.1 Turn off the whole battery string's power. Must confirm the D+ and D- terminal are without power. The turn off progress refer to chapter 3.6.5.

5.2.2.2 Pull out the plugs of Power Cables and the communication plugs.



Danger: the power cables still have high voltage DC power from another battery modules, must be careful to handle the Power plugs.

5.2.2.3 Dismantle the 4 screws of the battery module's front face.



5.2.2.4 Install the new control module (BMS). And reconnect all the cables. Refer to chapter 3.5.

5.2.2.5 Turn on this battery string. Refer to chapter 3.6.



Caution: Before pull out the communication cables must mark the cable number, to avoid cable wrong sequence.

5.2.3 Replacement of 3rd level Control Module (MBMS)

5.2.3.1 Turn off the Power Switch. Refer to chapter 3.6.5.



Caution: Turn off this MBMS will stop the power output of belonging whole Battery Energy Storage System.

5.2.3.2 Dismantle the 4 screws.



5.2.3.3 Install the new MBMS inside. And reconnect the cables. Refer to chapter 3.5.

5.2.3.4 Turn on this MBMS. Refer to chapter 3.6.



Caution: Before pull out the communication cables must mark the cable number, to avoid cable wrong sequence.



5.3 Battery Maintenance

Danger: The maintenance of battery must done by qualified and authorized personnel only.

Danger: Some maintenance items must turn off at first.

5.3.1 Voltage Inspection:

[Periodical Maintenance] Check the voltage of battery system through the monitor system. Check the system abnormal voltage or not. For example: Single cell's voltage is abnormal high or low.

5.3.2 SOC Inspection:

[Periodical Maintenance] Check the SOC of battery system through the monitor system. Check the battery string abnormal SOC or not.

5.3.3 Cables Inspection:

[Periodical Maintenance] Visual inspect all the cables of battery system. Check the cables has broken, aging, getting loose or not.

5.3.4 Balancing:

[Periodical Maintenance] The battery strings will become unbalance if long time not be full charged. Solution: every 3 month should do the balancing maintenance (charge to full), normally it will been done automatically by the communication between system and external device.

5.3.5 Output Relay Inspection:

[Periodical Maintenance] Under low load condition (low current), control the output relay OFF and ON to hear the relay has click voice, that's mean this relay can off and on normally.

5.3.6 History Inspection:

[Periodical Maintenance] Analysis the history record to check has accident (alarm and protection) or not, and analysis its reason.

5.3.7 Shutdown and Maintenance:

[Periodical Maintenance]

Some system function must be maintenance during the EMS restart, it is recommended to maintenance the system every 6 months.

6. Storage Recommendations

b) For long-term storage (more than 3 months), the battery cells should be stored in the temperature range of 5–45°C, relative humidity <65% and contains no corrosive gas environment.

The battery module should shelved in range of 5–45°C, dry, clean and well ventilated environment. Before storage the battery should be charged to 50–55% SoC;

It is recommended to active the chemical (discharge and charge) of the battery every 3 months, and the longest discharge and charge interval shall not exceed 6 months.



Caution: If not follow the above instructions for long term store the battery, The cycle life will have relative heavily reduction.

7. Shipment

Battery module will pre-charged to 50%SOC or according to customer requirement before shipment. The remaining capacity of battery cell, after shipment and before charge, is determined by the storage time and condition.

1. The battery modules meet the UN38.3 certificate standard.
2. In particular, special rules for the carriage of goods on the road and the current dangerous goods law, specifically ADR (European Convention on the International Carriage of Dangerous Goods by Road), as amended, must be observed.

Annex 1: Cable connection diagram



Annex 2: Installation and System Turn ON Progress List

Tick after completion	No.	Item	Remark
<input type="checkbox"/>	1	The environment is meeting all technical requirements. 3.3.1 Cleaning 3.3.2 Temperature 3.3.3 Radiating System 3.3.4 Heating System 3.3.5 Fire-extinguisher System 3.3.6 Grounding System	Refer to chapter 3.3
<input type="checkbox"/>	2	Battery rack is installed follow the technical requirements.	Refer to chapter 3.5.3.
<input type="checkbox"/>	3	Control Module (BMS) and Battery Module are installed well.	Refer to chapter 3.5.4.
<input type="checkbox"/>	4	The MBMS are installed well. (If configured.)	Refer to chapter 3.5.5.
<input type="checkbox"/>	5	Connect External Power Cable +/- between each BMS to the PCS or confluence cabinet.	Refer to chapter 3.6.2.
<input type="checkbox"/>	6	Connect power cables of each battery string.	Refer to chapter 3.6.2.
<input type="checkbox"/>	7	Connect communication cables of each battery string.	Refer to chapter 3.6.2.
<input type="checkbox"/>	8	Set up ADD switch of every BMS and the MBMS (Address Assignment).	Refer to chapter 3.6.3.
<input type="checkbox"/>	9	Connect external communication cables from BMS to BMS, MBMS, inverter, PCS or another.	Refer to chapter 3.6.2.
<input type="checkbox"/>	10	Connect the communication cable from MBMS to the PCS.	Refer to chapter 3.6.2.
<input type="checkbox"/>	11	Double check every power cables, communication cables installed well. And ADD Switches are setting right.	Refer to chapter 3.6.2 and 3.6.3.

<input type="checkbox"/>	12	Check the UPS is turned on. And the UPS is power supplying. (If configured)	Refer to chapter 3.6.4.
<input type="checkbox"/>	13	Switch the external power or PCS on, to sure all the power equipments can work normally.	Refer to chapter 3.6.4.
<input type="checkbox"/>	14	Turn the BMS (Battery Control Modules) of each battery string on (from 1 st BMS to the last, one by one) <ul style="list-style-type: none"> ● Turn on the "POWER RELAY SWITCH": ● Turn on the "Power Switch": ● The battery string's system will check itself, if work normal the battery string system will goes into self-check mode. <p>If has failure during the self-check, must debug the failure then can start next step.</p>	Refer to chapter 3.6.4.
<input type="checkbox"/>	15	If every battery string are working normally. Then switch the MBMS on . The MBMS will self-check and check each battery string one by one.	Refer to chapter 3.6.4.
<input type="checkbox"/>	16	The first installation should do full charging progress. After MBMS has communicated with each BMS, it will run parallel operation. It will begin from lowest voltage battery string to do the parallel operation during the charging. If the status LED of BMS turns to green, it means this battery string is in parallel operation.	The first installation should do full charging progress.

Annex 3: System Turn OFF Progress List

Tick after completion	No.	Item	Remark
<input type="checkbox"/>	1	Soft-off the PCS through PCS's control panel.	Refer to chapter 3.6.5.
<input type="checkbox"/>	2	Turn off the switch between PCS and this battery string (PowerCube-H1/H2), or turn off the power switch of PCS, to make sure no current through this battery string.	Refer to chapter 3.6.5.
<input type="checkbox"/>	3	Turn off all the "Power Switch" of the BMS.	Refer to chapter 3.6.5.
<input type="checkbox"/>	4	Turn off the "Power Switch" of the MBMS.	Refer to chapter 3.6.5.
<input type="checkbox"/>	5	Turn off the UPS. (If configured.) <ul style="list-style-type: none"> ● The UPS can turn on to check the equipments (PCS or battery system etc.). Otherwise must turn off the UPS to save its power. 	Refer to chapter 3.6.5.



PYLONTECH

Pylon Technologies Co., Ltd.

No. 73, Lane 887, ZuChongzhi Road, Zhangjiang Hi-Tech Park
Pudong, Shanghai 201203, China

T+86-21-51317697 | F +86-21-51317698

[Eservice@pylontech.com.cn](mailto:service@pylontech.com.cn)

[Wwww.pylontech.com.cn](http://www.pylontech.com.cn)